

MLA210 User Guide

www.mcgrathsmartlocks.com.au



McGrathlocks APP INSTALLATION REQUIRED

Enable your smart phone to scan QR code to download the APP. Also you can search "McGrathlocks" on APP store or Google play to download the APP.

DOWNLOAD & INSTALL

1 PRODUCT SPECIFICATION

Front Panel

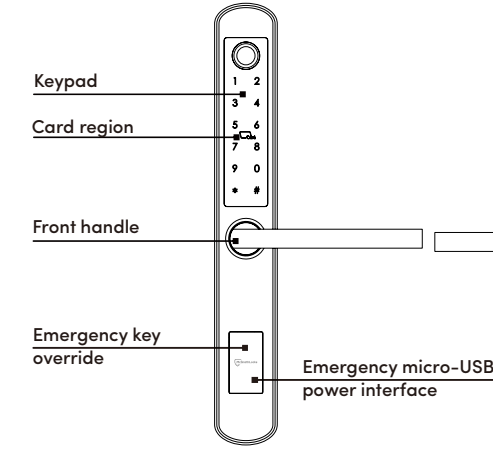

Back Panel

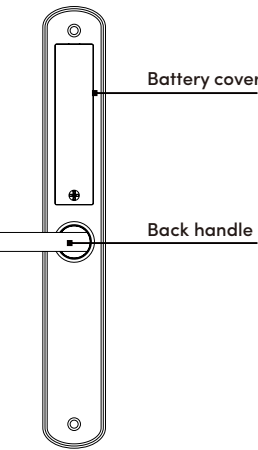

2 RESET TO FACTORY STATE

Attention

To restore the lock to factory settings; press and hold the reset button for 2 seconds until you hear two beeps. The default passcode is 123456#.

In factory mode, the lock remains in an always-open state. When the lock is powered on, the motor will reset and the handle will return to a free (unlocked) state.

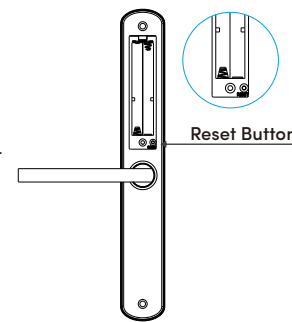

3 LOCK ACCESSORIES

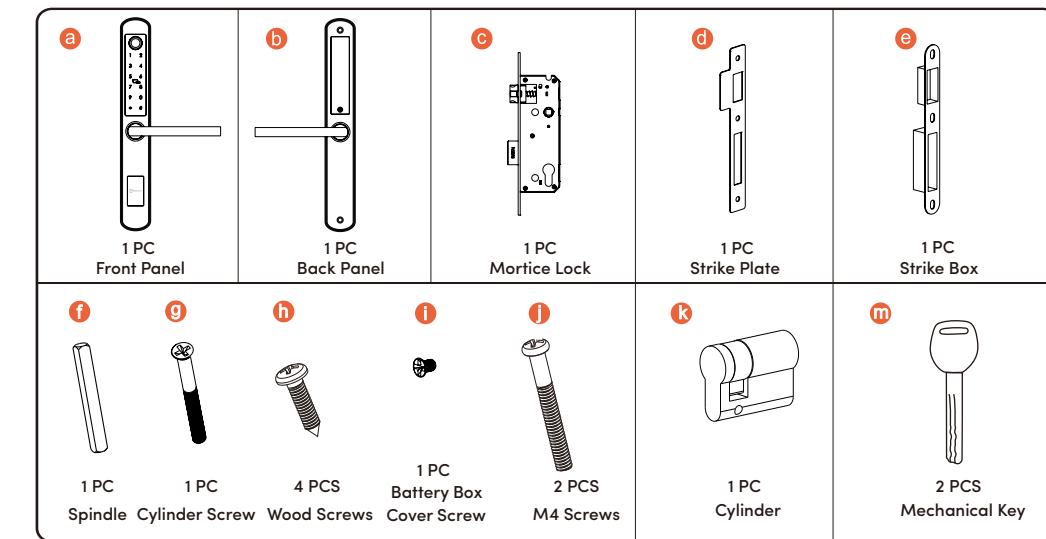

4 EXPLODED VIEW

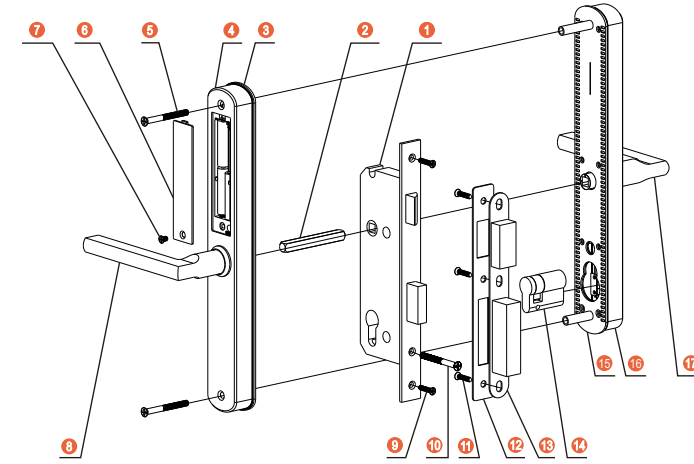

NO.	Name	Quantity	NO.	Name	Quantity
1	Mortise	1	10	Cylinder Screw	1
2	Spindle	1	11	Strike Plate Screw	3
3	Rubber Gasket	1	12	Strike Plate	1
4	Back Panel	1	13	Strike Box	1
5	Fixing Screw	2	14	Cylinder	1
6	Battery Cover	1	15	Front Gasket	1
7	Battery Cover Screw	1	16	Front Panel	1
8	Back Handle	1	17	Front Handle	1
9	Faceplate Screw	2			

5 PREPARING TO INSTALL

5.1 Line drawing

Draw a horizontal centerline on both the inside and outside of the door, positioned 1 meter above the ground.

Fold the hole template and align the handle centerline on the template with the centerline on the door. Then, mark the hole positions on both the front and the edge (side) of the door.

 Please check and confirm that the template drawing is compatible with the mortise lock provided.

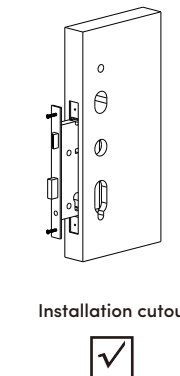
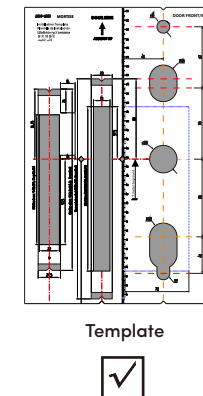

5.2 Door opening direction

1 Right handle opening

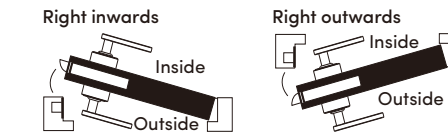

2 Left handle opening

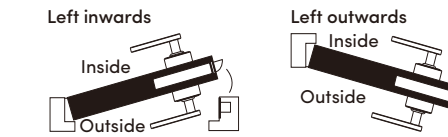

5.3 Adjust the handle direction

1. Adjust the front handle direction

- 1.1 Remove the screw on the inside of the handle with the hex wrench.
- 1.2 Take off the handle.
- 1.3 Rotate the handle 180 degree according to your need.
- 1.4 Re-tighten the screw with the hex wrench.
- 1.5 Adjust the clutch direction as the sign on the right.

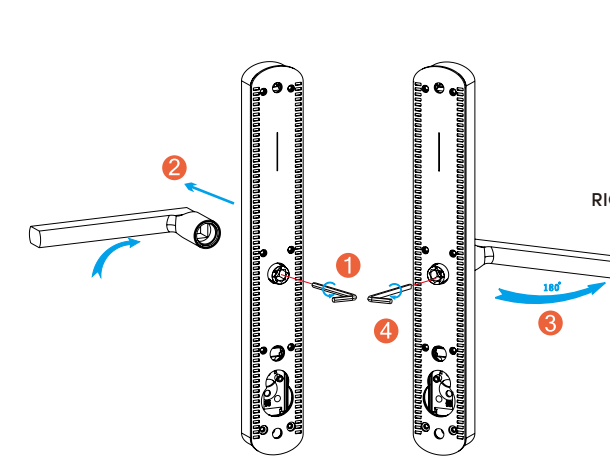

Note: Lock must be powered to change the clutch direction.

Right Open

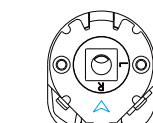

RIGHT SIGN ON CLUTCH

Left Open

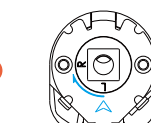

TURN RIGHT TO LEFT

2. Adjust the back handle direction

- 2.1 Remove the screw on the inside of the handle with the hex wrench.
- 2.2 Take off the handle.
- 2.3 Rotate the handle 180 degree according to your need.
- 2.4 Re-tighten the screw with the hex wrench.

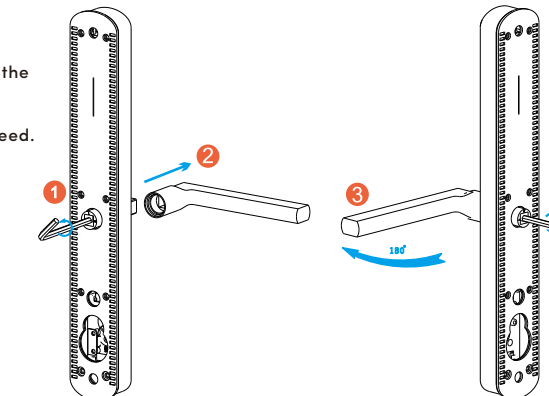

6 INSTALL THE LOCK

6.1 Install the mortise

Insert the mortise (C) into the slot that was drilled according to the template.

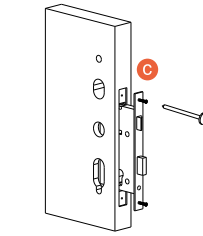

6.3 Install the front panel

Tighten the front panel on the door(outside).

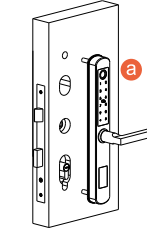

6.5 Install the strike and strike box

Insert the strike box into the slot and secure the strike with the screws(H).

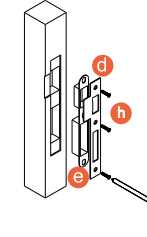

6.7 Test the lock

Insert 4 AAA alkaline batteries into the battery holder, then test the lock using the factory passcode or the app.

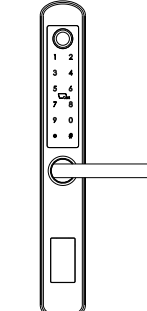

6.2 Install the cylinder

Secure the cylinder (K) using the long screw, passing it through the designated hole in the faceplate.

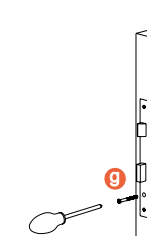

6.4 Install the back panel

Tighten the back panel onto the door(inside) to the front panel using the two long screws (J).

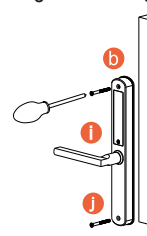

6.6 Test with emergency key

Test unlocking the door with the emergency key, and adjust the position if it does not operate smoothly.

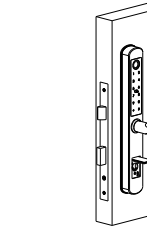

6.8 Adjust the lock panel

After testing, adjust the position of the lock panel or the screws if the operation feels too tight.

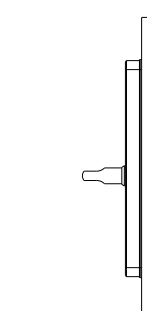

RECOMMENDED: LOCK SETUP WITH APP

It is highly recommended to set up the lock using the McGrathlocks app.

The app simplifies programming and provides an easier way to manage your locks.



DOWNLOAD & INSTALL

Manual set up via keypad only

Please follow the instructions below to manually program the lock using the keypad.

You can add a BLE device after the lock is programmed manually provided you know the admin code.

*83# > Admin code# > Add lock via APP

CREATE NEW ACCESS

Add administrator (only 1)

*12# > 123 456# > New Code# > New Code#

- Enter *12#
- Input 123456# (the default code)
- Input new code#
- Repeat new code#

Add a new user with an access / pin code (250 maximum)

*80# > Admin Code# > New Code# > New Code#

- Enter *80#
- Input admin code#
- Input user code# (6-9 digits)
- Repeat new user code#

Tips: If you use the APP a 4 digit user code can be set.

Add a new user with an RFID card (1000 maximum)

*80# > Admin Code# > RFID

- Enter *80#
- Input admin code#
- Present the card to the card sensor area

Add a new user with fingerprint (100 maximum)

*80# > Admin Code# > Input Fingerprint

- Enter *80#
- Input admin code#
- Present fingerprint several times according to the voice guide.

MODIFY CODE

Modify admin code

*12# > Admin Code# > New Code# > New Code#

- Enter *12#
- Input old admin code#
- Input new admin code#
- Repeat the new admin code#

Modify user code

*10# > User Code# > New Code# > New Code#

- Enter *10#
- Input old user code#
- Input new user code#
- Repeat the new user code#

DELETE USER

Delete specified pin code

*72# > Admin Code# > Specified code#

- Enter *72#
- Input admin code#
- Input the specified code# that you wanted to delete

Tips: The admin code cannot be deleted.

Delete all fingerprints

*70# > Admin Code#

- Enter *70#
- Input admin code#

Tips: The admin code cannot be deleted.

Delete all user codes

*71# > Admin Code#

- Enter *71#
- Input admin code#

Delete all RFID cards

*69# > Admin Code#

- Enter *69#
- Input admin code#

MANAGE VOICE

Turn on the lock voice

*30# > Admin Code# > 1#

- Enter *30#
- Input admin code#
- Input 1#

Turn off the lock voice

*30# > Admin Code# > 0#

- Enter *30#
- Input admin code#
- Input 0#

DEMO MODE

Demo mode is turned off by default prior to an Admin code being registered. If you wish to turn on demo mode input 24679#. Demo mode sets the lock access pin code to 123456# and any card or fingerprint will also open it. Registering an Administrator will take the lock out of demo mode.

LOW BATTERY ALERT

When battery power is less than 4.8V you will hear a low battery alert each time you wake the lock screen. Please replace batteries with new Alkaline type. Don't mix old and new batteries.

SCRAMBLING CODE FOR ANTI PEEP

Users may enter any random digits before or/and at the end of entering their correct pin code and still gain access. This feature makes it harder for an unauthorised user who may be watching you to guess your pin code.

INCORRECT CODE / CARD ALERT

If the wrong unlocking information is inputted five times the system will be locked out for 2 minutes. The lock can only be operated by the APP during the lockout period.

PASSAGE MODE

Passage mode keeps the door unlocked, useful when gardening or bringing in groceries from the car etc.

To activate passage mode, enter a valid unlock code then press 123# within 5 seconds. The door will remain unlocked.

To remove from passage mode, unlock using a valid code or card. If you engage passage mode via the APP you must use the APP to disengage passage mode.

FAQS

Keypad on lock does not respond

- Please check the batteries are installed correctly.
- If the lock had been working OK, please replace the batteries with new AA Alkaline type.

The door will not lock

- Ensure the lock is not in demo mode.
- Check to see if the lock is in passage mode.
- Refer to installation guide to ensure the triangle on the lock hub is in correctly aligned.

Battery performance is poor.

- Ensure all batteries are new Alkaline type.
- Ensure the lock connecting cable is not pinched.
- Check for and update lock firmware.

GATEWAY

Gateway type

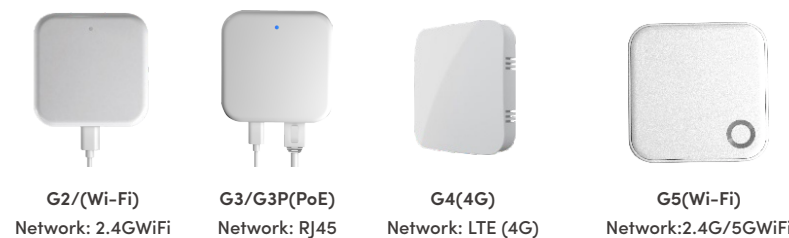

ADD GATEWAY

- Open the McGrath Locks app and log in to your administrator account.
- Tap the menu icon (☰) in the top left corner of the home screen.
- Select 'Gateway' from the sidebar menu.
- Tap the "+" symbol in the top right corner.
- Choose your gateway model from the list provided.
- Connect the gateway to power, while the light is alternatively flashing red and blue, press the "+" symbol.
- Select the network required, enter the Wi-Fi password, enter the gateway name.

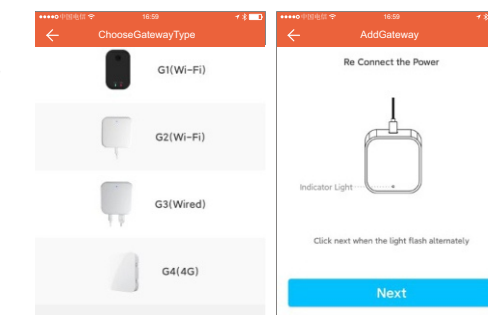

Notice: If the process times out, please disconnect from power and try again.
*Gateway coverage distance: 10 meters without obstruction

Gateway functionality

The gateway is an accessory for the lock that connects it to the network. With a gateway connected you can remotely manage the lock, such as opening the door or deleting a passcode.

GatewayFunctions	Without Gateway	With Gateway	
Assign random pin codes	✓	✓	The door lock can function normally without a gateway. However, to remotely modify or delete pin codes, issue fingerprints or cards, open the door remotely and access other features, a gateway is required.
Door Opening with App	✓	✓	
Set permissions	✓	✓	
Remotely modify and delete pin codes	✗	✓	
Remote card issuance	✗	✓	
Open door remotely	✗	✓	
Upload door records log in real time	✗	✓	